

# SCHEDA TECNICA



*cucina*

TEAM7



# SOMMARIO

## *materiali*

legno	3
vetro colorato	3
ceramica	4
maniglie	4

---

## *spiegazione sistema*

gusto in purezza	5
curiosando al mercato	5
passeggiata nel bosco	6

---

## *consigli per la progettazione*

divisione dei frontali	7
riepilogo misure	8

---

## *moduli*

basi	9-11
colonne	12-15
pensili	16-17
pensili con illuminazione	18-19

---

<i>note</i>	20
-------------	----

## tipi di legno

Se non diversamente indicato, tutte le superfici in legno sono trattate con olio naturale.

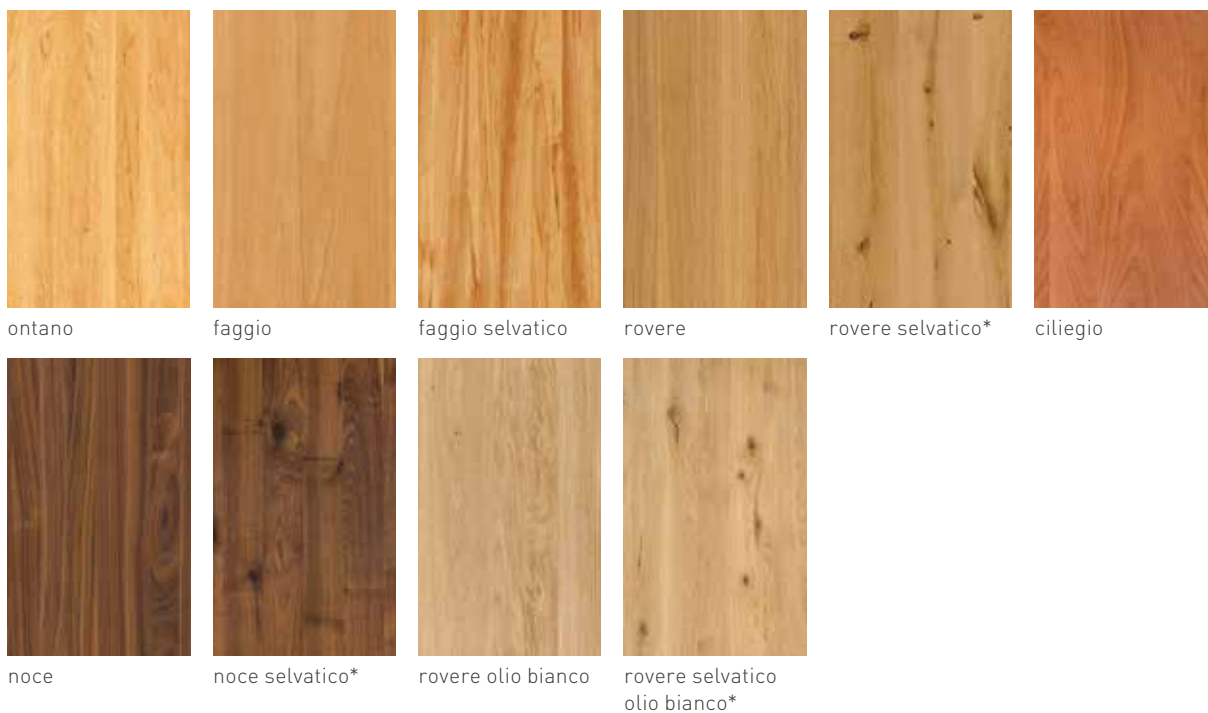

## vetro colorato

lucido o opaco | tutte le superfici in vetro in un colore a scelta (sistema cromatico NCS, con sovrapprezzo)



### campioni colore

Il legno è uno dei prodotti naturali più nobili, più belli e più versatili. Ogni pezzo di legno è unico. Le differenze di colore dipendono dalla struttura, dalla zona in cui è cresciuto il legno e anche dall'età del mobile, perché sotto gli influssi naturali dell'ambiente (come ad esempio la luce diurna) la tonalità della superficie si modifica. Producendo sulla base di un campionario colori, facciamo sempre il possibile per rispettare la tonalità di riferimento. Tuttavia, nel caso di materiali quali il legno, il vetro o il tessuto, si avranno leggere differenze di tonalità. Ottenere un'assoluta uniformità di colore non è possibile.

\*variante selvatica disponibile solo per i frontali

## ceramica

Utilizzo: frontali, piani di lavoro (solo una selezione delle finiture disponibili sul mercato)



arctic white















phedra

cement

iron grey

basalt black

## aperture

profili					
	<b>profilo (GPS)</b> finitura acciaio inox nero	<b>profilo (GPE)</b> finitura acciaio inox	<b>maniglia ad asta (FGS)</b> maniglia a filo finitura acciaio inox   nero	<b>maniglia ad asta (FG)</b> maniglia a filo finitura acciaio inox	
	senza maniglie				
		<b>gota (GFU)</b> finitura acciaio inox	<b>servo-drive (AP-SD)</b> elettrico <b>meccanismo touch (AP-TD)</b> meccanico		
impugnatura ad asta					
	<b>impugnatura metallica (MGS)</b> finitura acciaio inox; nero	<b>impugnatura metallica (MG)</b> finitura acciaio inox	<b>ad asta (SEF)</b> finitura acciaio inox	<b>ad asta (SEN)</b> legno (faggio, rovere, rovere olio bianco, noce)	
	impugnatura ad asta				
		<b>maniglia ad asta (GKU)</b> cubica finitura acciaio inox	<b>maniglia ad asta (GO)</b> ovale finitura acciaio inox	<b>maniglia (GR)</b> tonda acciaio inox	<b>maniglia ad asta (EF)</b> tonda finitura acciaio inox



## spiegazione sistema

Le cucine TEAM 7 sono uniche come il vostro stile di vita. Scoprite tutta la varietà della nostra gamma cucine!

### GUSTO IN PUREZZA

Cucine che occupano gli spazi con linee pulite ed eleganti, riunendo semplicità e funzionalità.



### CURIOSANDO AL MERCATO

Modelli di cucine con una varietà di opzioni praticamente illimitata, per personalizzare progetti di qualsiasi dimensione e stile.



## PASSEGGIATA NEL BOSCO

Vivere con tutti i sensi la pienezza del legno autentico è il concetto alla base delle nostre cucine.



### consigli per la progettazione

divisione frontali/altezza moduli: H 67,0 cm e H 80,4 cm

#### esempio divisione frontali

U\_80L2A2\_  
 altezza singolo modulo: 13,4 cm  
 distanza tra i frontali: 0,4 cm

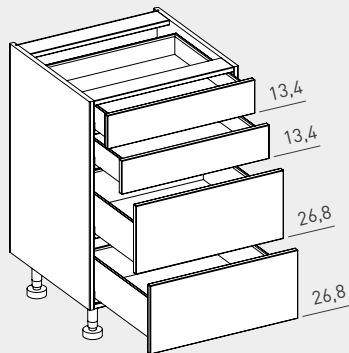

I nostri disegni vengono sempre forniti con le quote necessarie, compresa la distanza del frontale.

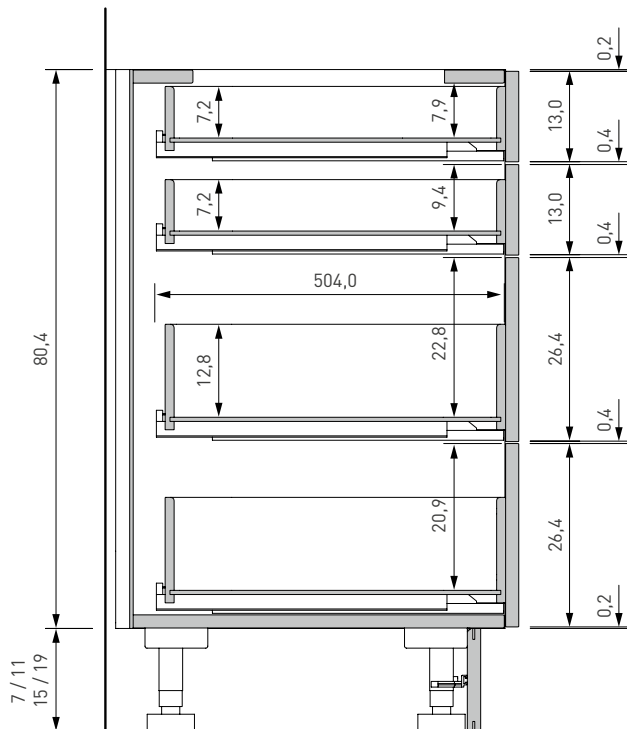

altezza basi 67,0 cm

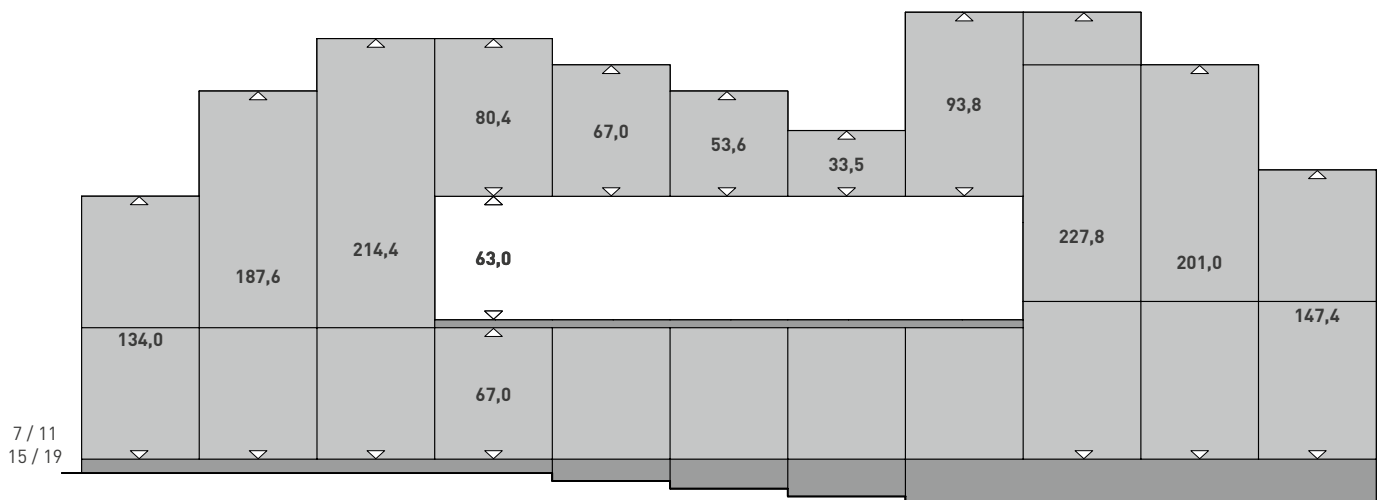

altezza basi 80,4 cm

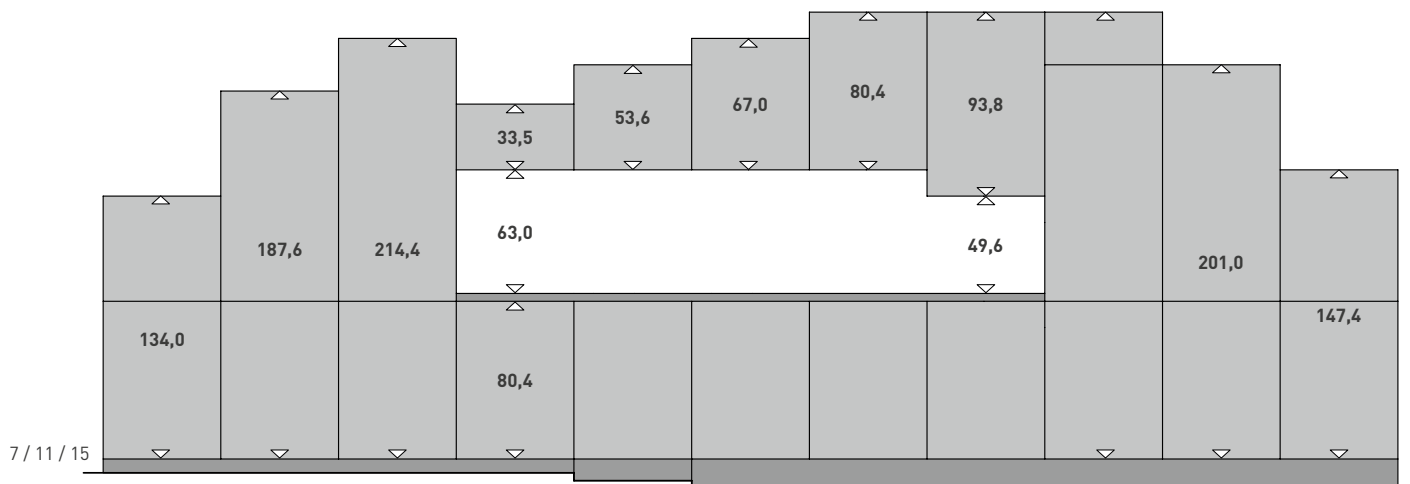





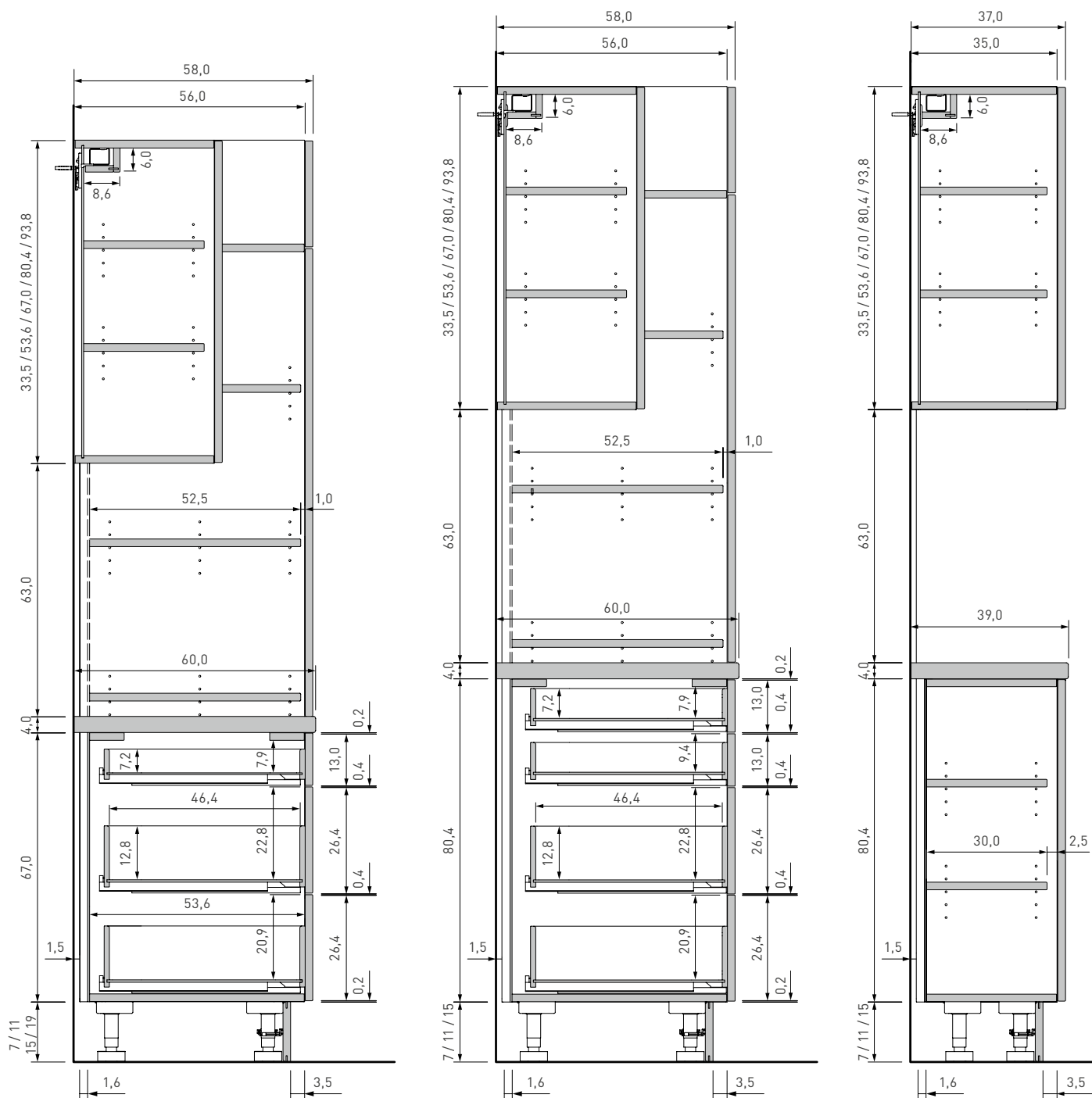





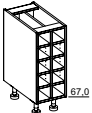
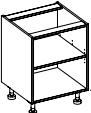

# consigli per la progettazione

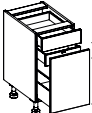
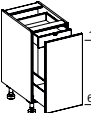
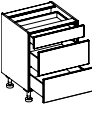
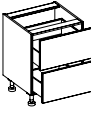
riepilogo misure

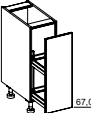
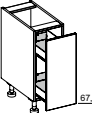

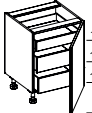

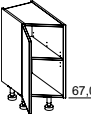
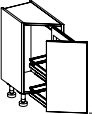
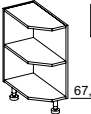

basi linee | echt.zeit | loft | rondo





altezza: 67,0 cm

 30	<b>UF3067</b>	 67.0	<b>U_67</b>	 67.0	<b>U_67T_</b>	 13.4 53.6	<b>U_67TG_</b>	 13.4 53.6	<b>U_67LT_</b>
15/20/30/40/45/50/60/80/90/100/120									
 30/40/45/50/60	<b>U_67LAI_</b>	 11.0 67.0	<b>U_67AI_</b>	 13.4 26.8 26.8	<b>U_67LA2_</b>	 33.5 33.5	<b>U_67A2_</b>	 13.4 13.4 26.8	<b>U_67L3A_</b>
30/40/45/50/60/80/90/100/120									
 30/45/60	<b>U_67TI3_</b>	 67.0	<b>U_67AR_</b>	 67.0	<b>U_67AP_</b>	 var.	<b>U_67TB_</b>	 11.0 17.0 17.0 var.	<b>U_67TI3_</b>
15/20/30/40/45									
 160/180/200/240	<b>U_67ST_</b>	 67.0	<b>UR_67T_</b>	 67.0	<b>UR3067AR</b>	 67.0	<b>UARE3067</b>	 67.0	<b>UARR3067</b>
15/30									
 60/80/90/100/120	<b>UOR_80</b> <b>UOR_80S</b> <b>UOR_80L</b> <b>UOR_80LS</b>								



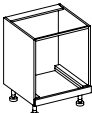

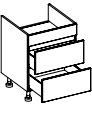



armadi angolari

 90/105	<b>UED_67T_</b>	 67.0	<b>UE9067K_</b>	 67.0	<b>UEG9067T_</b>	 67.0	<b>UEG_67LR_</b>	 67.0	<b>UEG_67LP_</b>
110									
110/115/125									

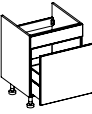
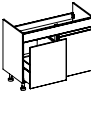
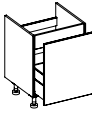
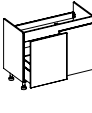
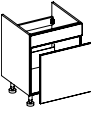
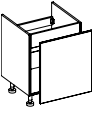
mobili da incasso per fornello





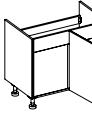





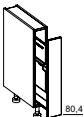
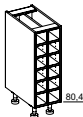

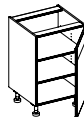
 60	<b>UH6067B_</b>	 13.4 26.8 26.8	<b>UK1_67LA2_</b>	 13.4 26.8 26.8	<b>UK2_67BA2_</b>	 13.4 26.8 26.8	<b>US_67A2_</b>		<b>MSNIK2_</b>
60/80/90/100/120									
90/100/120									

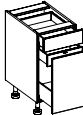
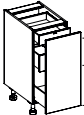
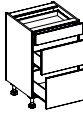
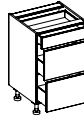
mobili da incasso per lavello

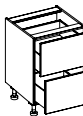
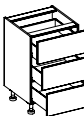
 45/50/60/80/90/100/120	<b>US_67BT_</b>	 67.0	<b>US_67T_</b>	 13.4 53.6	<b>US_67BA_</b>	 13.4 53.6	<b>US_67BAA_</b>	 67.0	<b>US_67A_</b>
45/50/60/80/90/100/120									
 80/90/100/120	<b>US_67AA_</b>	 13.4 53.6	<b>US_67B_</b>	 67.0	<b>US_67_</b>	 60	<b>MSNI60</b>	 45/60	<b>MSBL_</b>
45/60									
 40/45/50/60/90	<b>MSNIK_</b>	 13.4 53.6	<b>USD_67BT_</b>	 67.0	<b>USD_67T_</b>		<b>MSUSD</b>	 67.0	<b>USEG9067T_</b>
90/105									
90/105									
110									

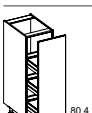
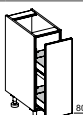
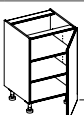

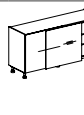
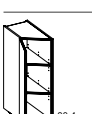
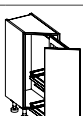
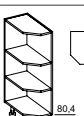
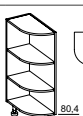
altezza: 80,4 cm

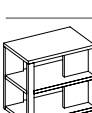
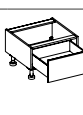
 U1580H_ 15	 UF3080 30	 U_80 15/20/30/40/45/50/60/80/90/100/120	 U_80T_ 15/20/30/40/45/50/60/80/90/100/120	 U_80TG_ 15/20/30/40/45/50/60/80/90/100/120
 U_80LT_ 30/40/45/50/60/80/90/100/120	 U_80LAI_ 30/40/45/50/60	 U_80AI2_ 30/40/45/50/60	 U_80LAA_ 30/40/45/50/60/80/90/100/120	 U_80LA2_ 30/40/45/50/60/80/90/100/120
 U_80L2A2_ 30/40/45/50/60/80/90/100/120	 U_80A2_ 30/40/45/50/60/80/90/100/120	 U_80A3_ 30/40/45/50/60/80/90/100/120	 U_80L4A_ 30/40/45/50/60/80/90/100/120	 U_80TI4_ 30/45/60
 U_80AR_ 15/20/30/40/45	 U_80AP_ 15/20/30	 U_80TB_ 15/20/30/40/45/50/60/80/90/100/120	 U_80TBI4_ 30/45/60	 U_80ST_ 160/180/200/240
 UR_80T_ 15/30	 UR3080AR_ 15/30	 UARE3080 30	 UARR3080 30	 UOR_80 UOR_80S UOR_80L UOR_80LS 60/80/90/100/120
 UOFR_80_ 60/80/90	 U_26A_ 45/50/60/80/90/100/120			

armadi angolari

 UED_80T_ 90/105	 UEG9080T_ 110	 UEG_80LR_ 110/115/125	 UEG_80LLR_ 110/115/125	 UEG_80LP_ 110/115/125
 UEG_80LLP_ 110/115/125	 UE9080K_ 90			

**mobili da incasso per fornello**

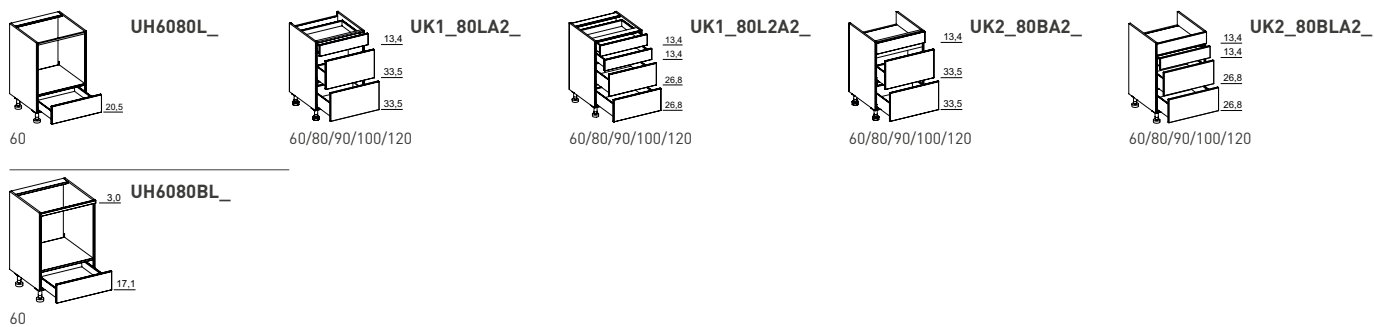



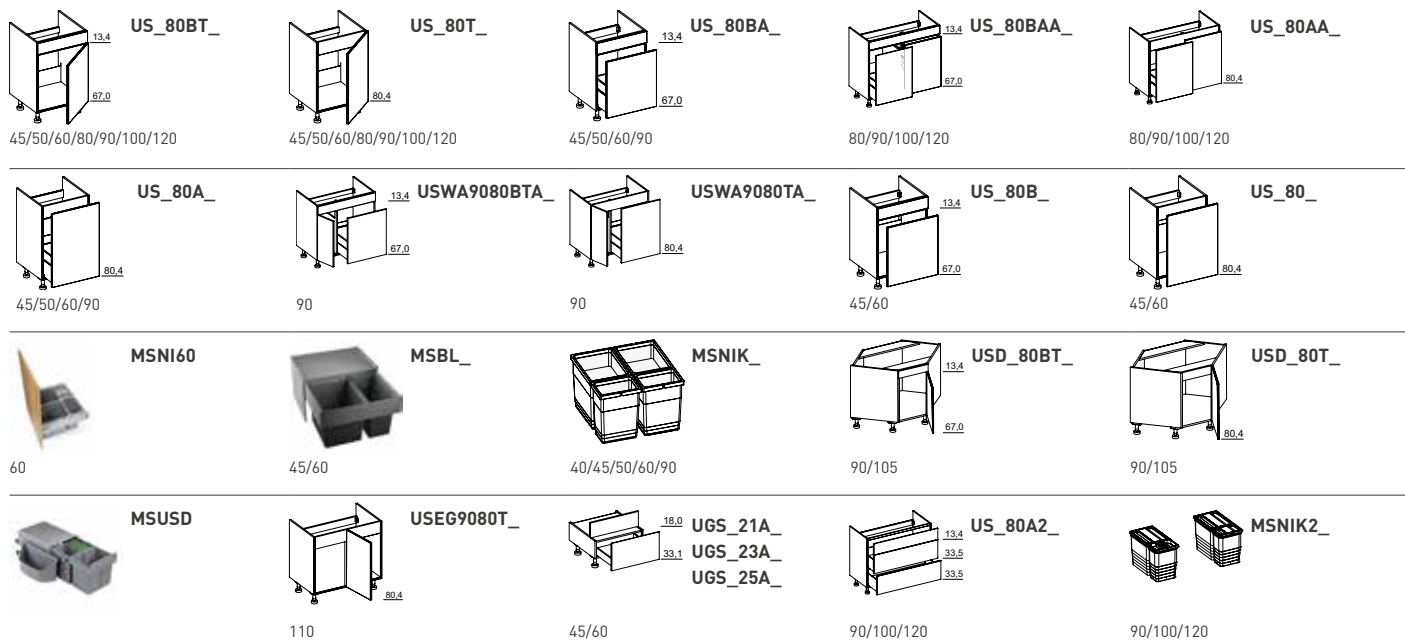



















**mobili da incasso per lavello**

























colonne linee | echt.zeit | loft | rondo

altezza: 134,0 cm























 30/40/45/50/60/80/90/100/120	 30/40/45/50/60/80/90/100/120	 30/45/60	 30/45	 30/45
 45/60	 30	 30	 90/100	 90/100
 120	 60	 60	 60	 60
 60	 60	 60	 60	 10/20
 60/80/90	 60/80/90			

altezza: 147,4 cm







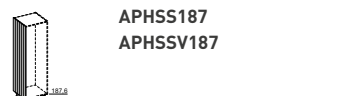

















 30/40/45/50/60/80/90/100/120	 30/40/45/50/60/80/90/100/120	 30/45/60	 30/45	 30/45
 45/60	 30	 30	 90/100	 90/100
 120	 60	 60	 60	 60
 60	 60	 60	 60	 10/20
 60/80/90	 60/80/90			

colonne linee | echt.zeit | loft | rondo

altezza: 187,6 cm







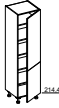
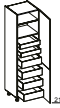
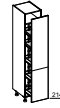

 30/40/45/50/60/80/90/100/120	 30/40/45/50/60/80/90/100/120	 30/45/60	 30/45	 30/45
 60	 60	 30	 30	 90/100
 90/100	 120	 60	 60	 60
 60	 60	 60	 60	 60
 60	 60	 10/20		

altezza: 201,0 cm

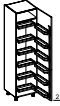
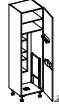
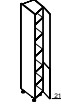

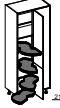
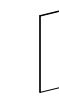
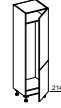

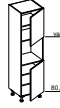
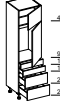
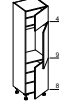
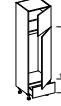
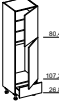
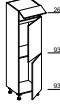
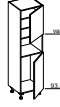
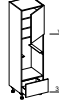

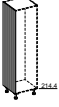
 30/40/45/50/60/80/90/100/120	 30/40/45/50/60/80/90/100/120	 30/45/60	 30/45	 30/45
 60	 60	 30	 30	 90/100
 90/100	 120	 60	 60	 60
 60	 60	 60	 60	 60
 60	 60	 60	 10/20	

colonne linee | echt.zeit | loft | rondo

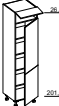
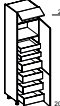
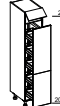
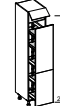
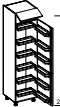
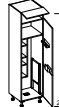
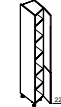
altezza: 214,4 cm

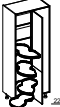
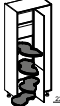
 30/40/45/50/60/80/90/100/120	 30/40/45/50/60/80/90/100/120	 30/45/60	 30/45	 30/45
 60	 60	 30	 30	 90/100
 90/100	 120	 60	 60	 60
 60	 60	 60	 60	 60
 60	 60	 10/20	 214,4	

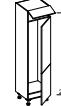
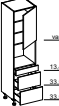
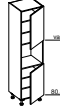
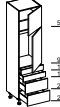
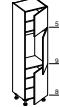
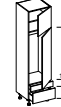
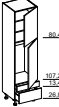
altezza: 227,8 cm

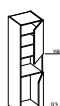
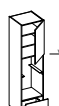
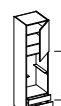
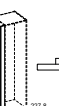
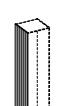
 30/40/45/50/60/80/90/100/120	 30/40/45/50/60/80/90/100/120	 30/45/60	 30/45	 30/45
 60	 60	 30	 30	 90/100
 90/100	 120	 60	 60	 60
 60	 60	 60	 60	 60
 60	 60	 60	 10/20	 227,8



colonne linee | echt.zeit | loft | rondo

armadio con ante scorrevoli-girevoli



HDS\_18713\_

69.3/138.6

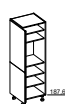

HGDS18760\_

69.3

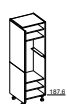

HGDS187G2\_

69.3



WSDS\_187  
WWDS\_187

1.2/1.9/2.5



HDS\_20113\_

69.3/138.6

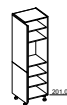

HGDS20160\_

69.3

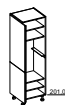

HGDS201G2\_

69.3

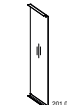

WSDS\_201  
WWDS\_201

1.2/1.9/2.5



HDS\_21413\_

69.3/138.6

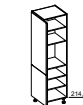

HGDS21460\_

69.3

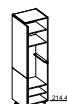

HGDS214G2\_

69.3

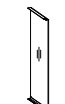

WSDS\_214  
WWDS\_214

1.2/1.9/2.5

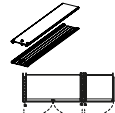

DSC\_

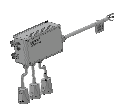

AADS

*pensili* linee | echt.zeit | loft | rondo

**altezza: 33,5 cm**

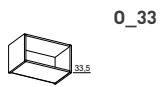

O\_33

15/20/30/40/45/50/60/80/90/100/120



O\_33K\_

30/40/45/50/60/80/90/100/120



O\_33KIAL

30/40/45/50/60/80/90/100/120

**altezza: 53,6 cm**



O\_53

15/20/30/40/45/50/60/80/90/100/120



O\_53T\_

15/20/30/40/45/50/60/80/90/100/120



O\_53KIAL



O\_53S\_

60/80/90/100/120



OA\_53SA\_

60/90



OFL6053T\_

60



OFL\_53T\_

90/100/120

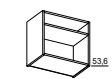

O\_53M

50/60



OARE3053

30



OARR3053

30



OEG\_53T\_

80/90

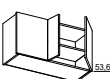

OEG\_53T\_

110/115/125



OE\_53

60/65/90

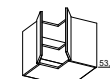

OE\_53T\_

60/65/90



OED6553T\_

65

**altezza: 67,0 cm**



O\_67

15/20/30/40/45/50/60/80/90/100/120



O\_67T\_

15/20/30/40/45/50/60/80/90/100/120

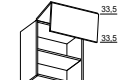

O\_67F\_

60/80/90/100/120

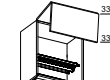

OA\_67FA\_

60/90



OFL6067T\_

60



OFL\_67T\_

90/100/120



OFL\_67F\_

90/100/120

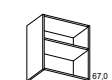

O\_67M

50/60

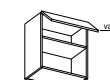

O\_67MK\_

50/60



OARE3067

30



OARR3067

30

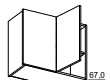

OEG\_67T\_

80/90

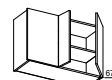

OEG\_67T\_

110/115/125

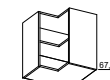

OE\_67

60/65/90

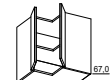

OE\_67T\_

60/65/90



OED6567T\_

65

**altezza: 80,4 cm**



O\_80

15/20/30/40/45/50/60/80/90/100/120



O\_80T\_

15/20/30/40/45/50/60/80/90/100/120



O\_80F\_

60/80/90/100/120

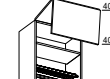

OA\_80FA\_

60/90



OFL6080T\_

60



OFL\_80T\_

90/100/120

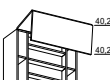

OFL\_80F\_

90/100/120

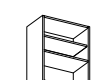

O\_80M

50/60



O\_80MT\_

50/60

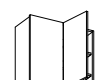

OEG\_80T\_

80/90



OEG\_80T\_

110/115/125

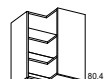

OE\_80

60/65/90



OE\_80T\_

60/65/90



OED6580T\_

65



OARE3080

30



**OARR3080**

30

**altezza: 93,8 cm**



**O\_93**

15/20/30/40/45/50/60/80/90/100/120



**O\_93T\_**

15/20/30/40/45/50/60/80/90/100/120



**OFL6093T\_**

60



**OFL\_93T\_**

90/100/120

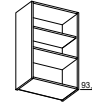

**O\_93M**

50/60



**O\_93MT\_**

50/60

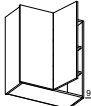

**OEG\_93T\_**

80/90

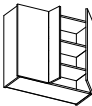

**OEG\_93T\_**

110/115/125



**OE\_93**

60/65/90



**OE\_93T\_**

60/65/90

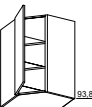

**OED6593T\_**

65

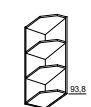

**OARE3093**

30

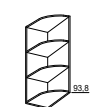

**OARR3093**

30

**elementi top**

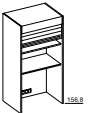

**A\_103RO  
A\_116RO  
A\_130RO  
A\_143RO  
A\_156RO**

60/80/90/100/120

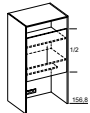

**A\_103VS\_  
A\_116VS\_  
A\_130VS\_  
A\_143VS\_  
A\_156VS\_**

60/80/90/100/120



**A\_1034RO  
A\_1164RO  
A\_1304RO  
A\_1434RO  
A\_1564RO**

60/80/90/100/120

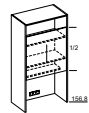

**A\_1034VS\_  
A\_1164VS\_  
A\_1304VS\_  
A\_1434VS\_  
A\_1564VS\_**

60/80/90/100/120

## informazioni prodotto sui pensili con illuminazione

Gli armadi possono essere dotati di illuminazione come da tabelle sottostanti. È possibile scegliere tra due tonalità di colore della luce: WW...bianco caldo oppure KW...bianco freddo.



colore luce:

Se al momento dell'ordine non vengono fornite indicazioni sul colore della luce, questa viene fornita automaticamente in WW...bianco caldo.

la predisposizione degli armadi implica articoli aggiuntivi.

### esempio:

Predisposizione di un pensile a giorno con un LED quadrato in alto e in basso, una canalina passacavi e un trasformatore con interruttore a sensore.

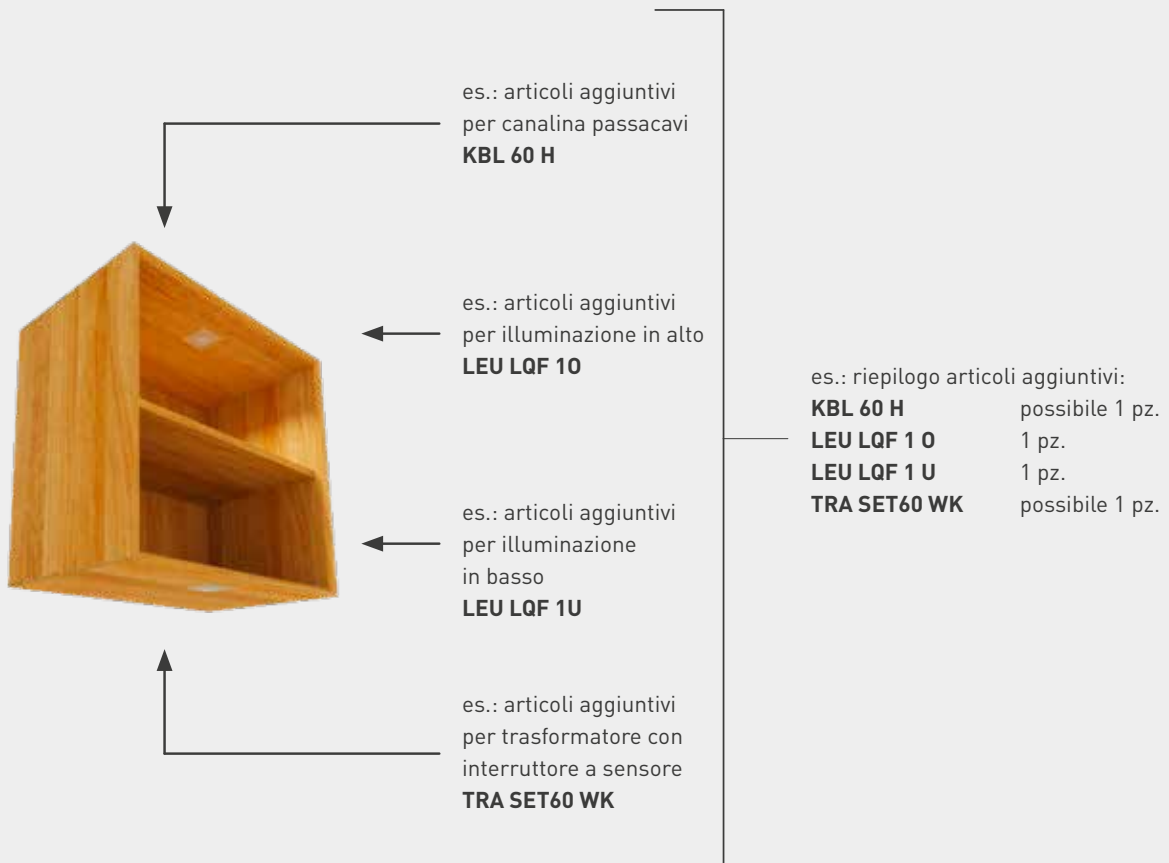

## informazioni prodotto sui pensili con illuminazione

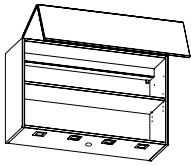
pensili con LED	
 <p>colore luce: 3200K ○WW...bianco caldo 5000K ○KW...bianco freddo</p>	
larghezza modulo	numero lampade LED/potenza
30	1 lampada LED / 3 W
40	1 lampada LED / 3 W
45	1 lampada LED / 3 W
50	1 lampada LED / 3 W
60	2 lampade LED / 6 W
80	2 lampade LED / 6 W
90	3 lampade LED / 9 W
100	3 lampade LED / 9 W
120	4 lampade LED / 12 W

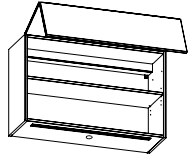
pensili con profilo LED	
 <p>colore luce: 3200K ○WW...bianco caldo 4000K ○KW...bianco freddo</p>	
larghezza modulo	lunghezza profilo LED / potenza
—	—
—	—
—	—
—	—
50	profilo LED 40 cm / 4,5 W
60	profilo LED 40 cm / 4,5 W
80	profilo LED 60 cm / 7 W
90	profilo LED 60 cm / 7 W
100	profilo LED 90 cm / 10,5 W
120	profilo LED 90 cm / 10,5 W



### interruttore a sensore:

sempre montato al centro  
(non visibile da fuori)

accensione, spegnimento e regolazione  
senza contatto



## illuminazione



LED tondo e regolabile  
finitura acciaio inox | nero



LED quadrato fisso  
nero opaco



LED quadrato fisso  
finitura acciaio inox



ponte di luce  
La temperatura colore della  
luce da 2.700 a 6.500 K



profilo LED da incasso  
finitura acciaio inox | nero



lampada sottopensile



*note*

---





Importanti informazioni sulle caratteristiche tipiche dei materiali con cui sono realizzati i mobili in legno naturale TEAM 7 sono disponibili nella documentazione relativa alla certificazione di qualità e manutenzione all'indirizzo [team7-home.com/pass-assistenza-qualita](https://www.team7-home.com/pass-assistenza-qualita)



**TEAM 7 Natürlich Wohnen GmbH**

telefono +43 7752 977-700 | e-mail [info@team7.at](mailto:info@team7.at) | [www.team7-home.com](http://www.team7-home.com)

**Austria** | 4910 Ried/Innkreis | Braunauer Straße 26

**Svizzera/Italia** | 5643 Sins/AG | Tschampani 30

# TEAM 7